

平成二十一年三月三十一日調製  
令和五年三月三十一日修正

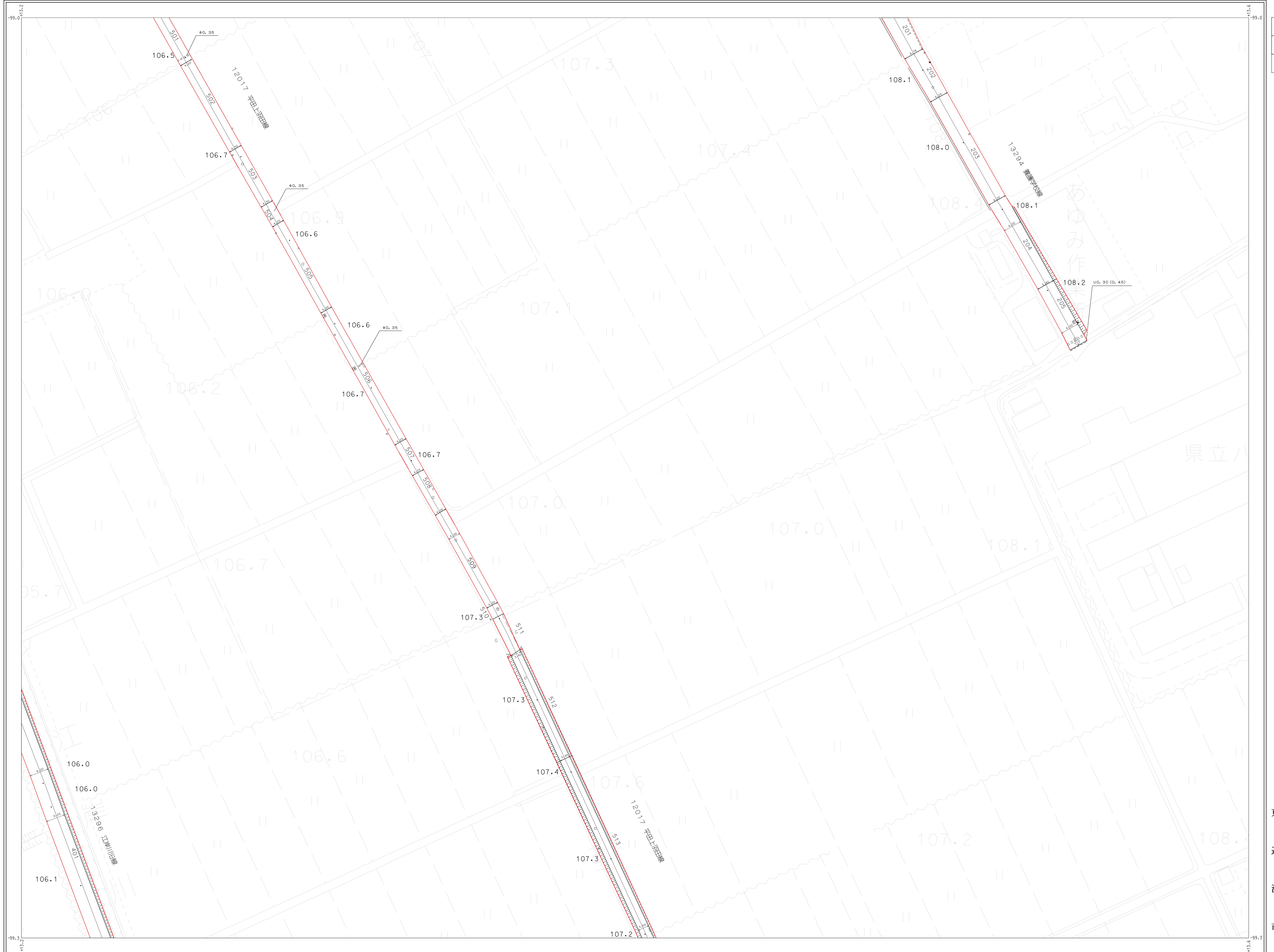

2106-3	2106-4	2107-3
2206-1	2206-2	2207-1
	2206-4	

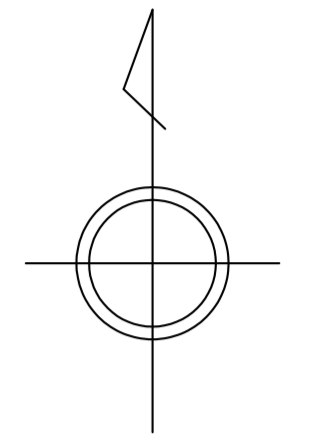

アジア航測株式会社調製

東  
近  
江  
市

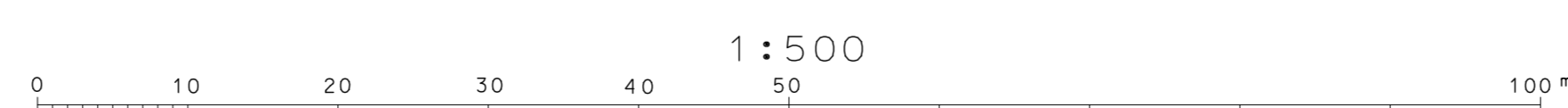

平成二十一年三月三十一日調製  
令和四年三月三十一日修正  
令和五年三月三十一日修正

2206-1	2206-2	2207-1
	2206-4	
2306-1	2306-2	2307-1

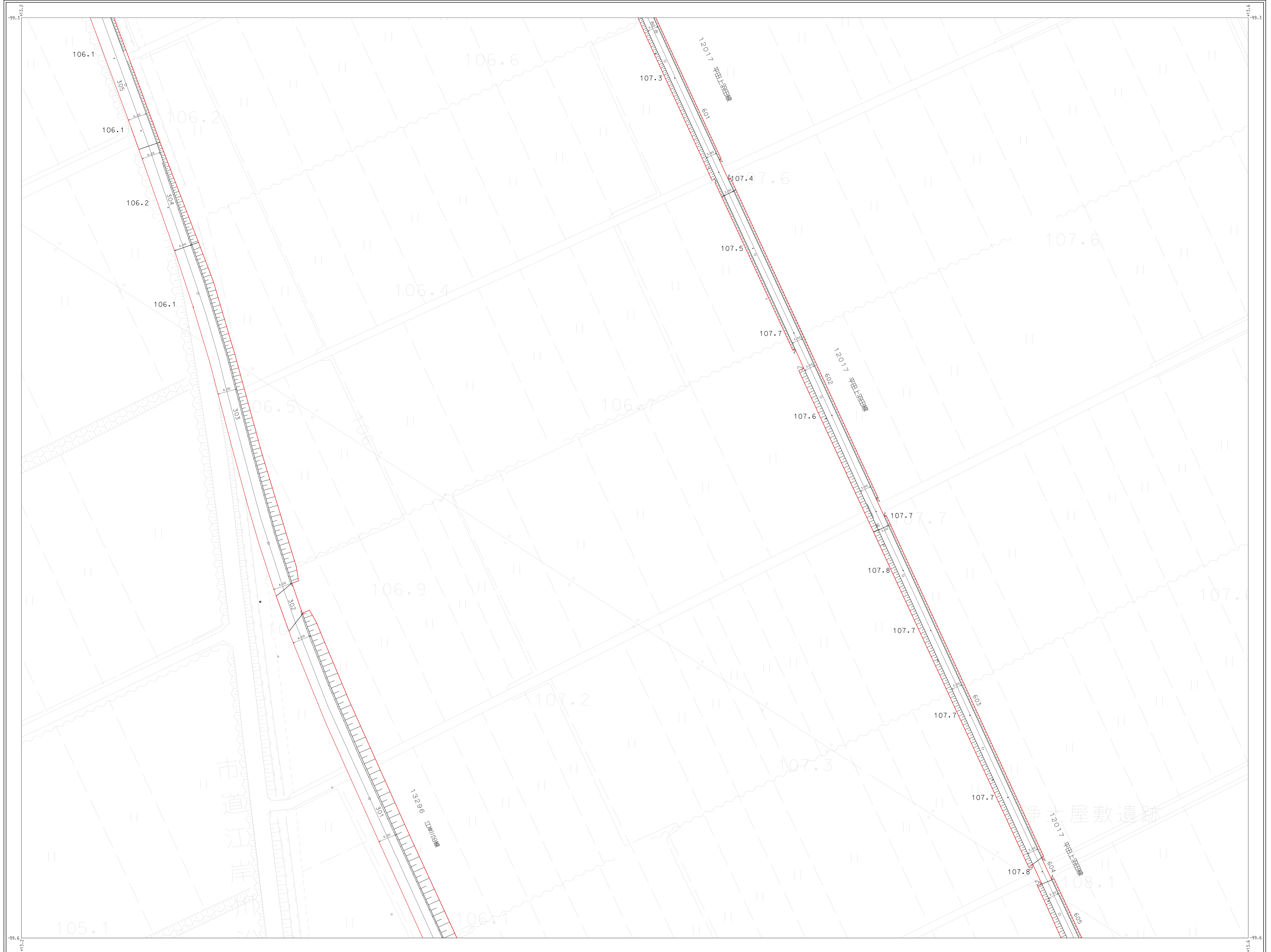
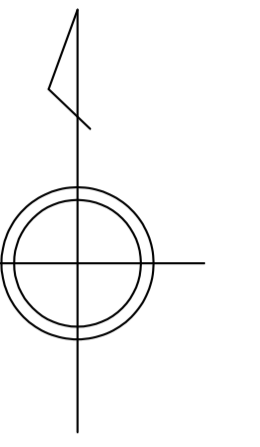

アジア航測株式会社調製

東  
近  
江  
市

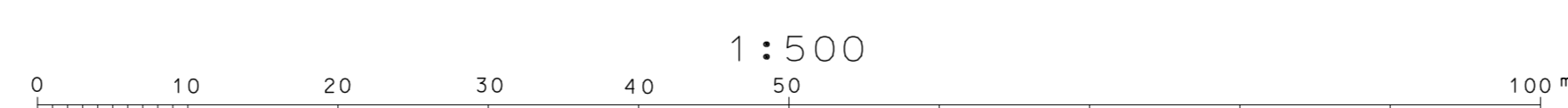

平成二十一年三月三十一日調製

2106-4	2107-3
2206-2	2207-1
2206-4	2207-4

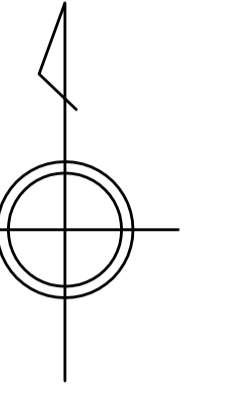

アジア航測株式会社調製

東  
近  
江  
市

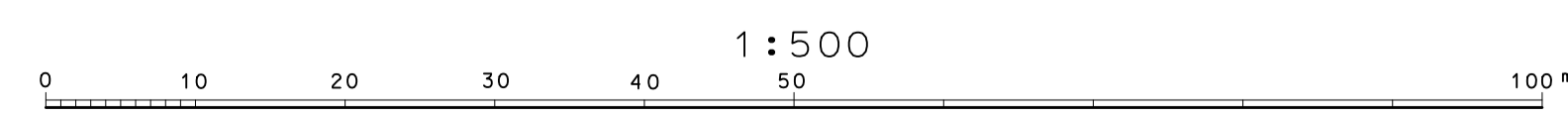

平成二十二年三月三十一日調製

アジア航測株式会社調製

2107-3		
2207-1	2207-2	2208-1
	2207-4	2208-3

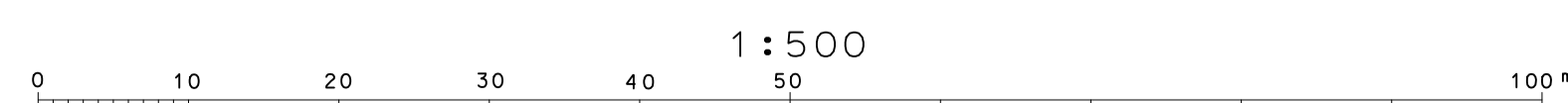
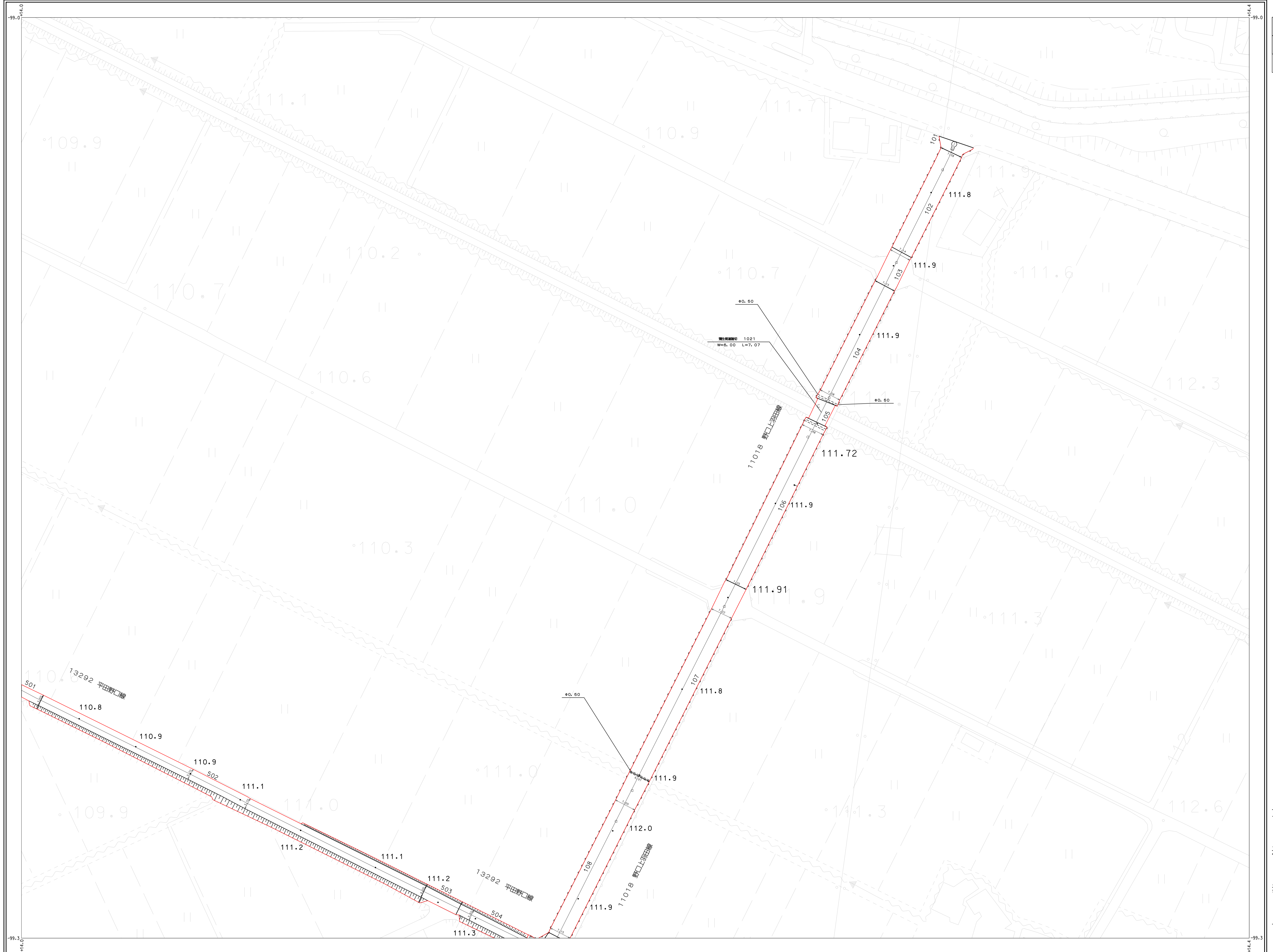
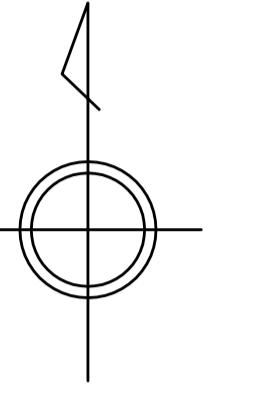

東  
近  
江  
市

平成二十一年三月三十一日調製

2207-1	2207-2	2208-1
	2207-4	2208-3
2307-1	2307-2	2308-1

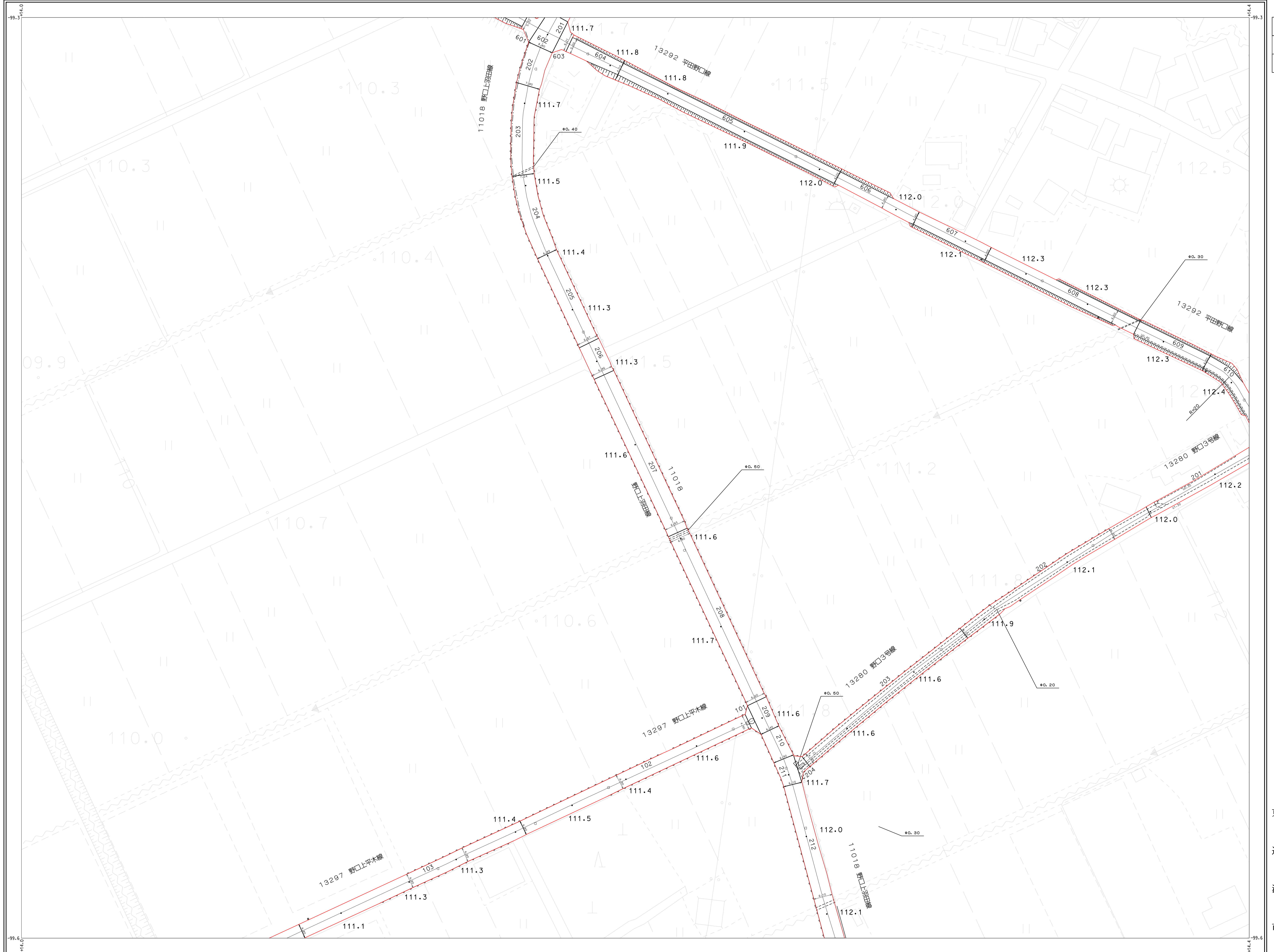
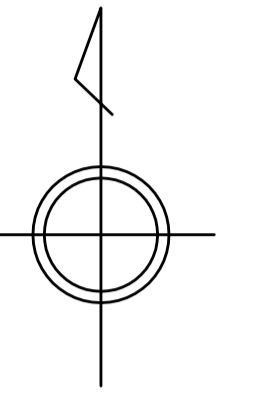

アジア航測株式会社調製

東  
近  
江  
市

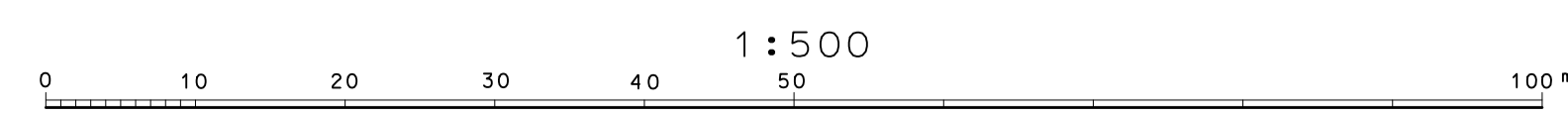

平成二十一年三月三十一日調製

		2108-4
2207-2	2208-1	2208-2
2207-4	2208-3	2208-4

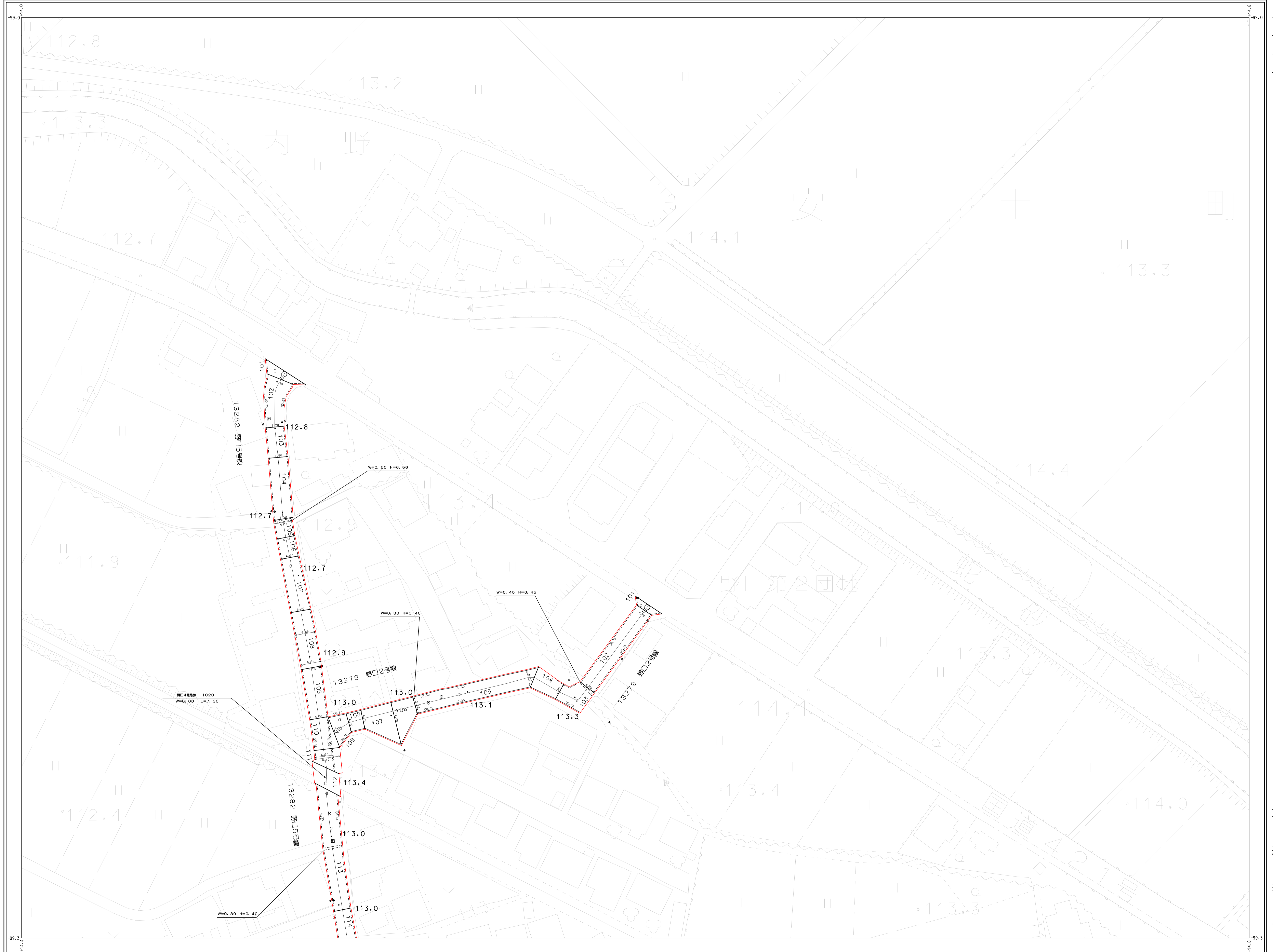
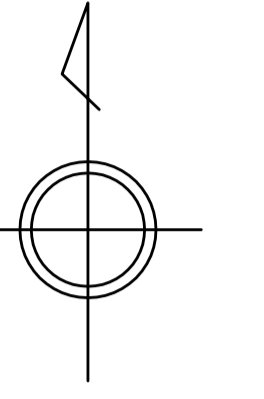

アジア航測株式会社調製

東  
近  
江  
市

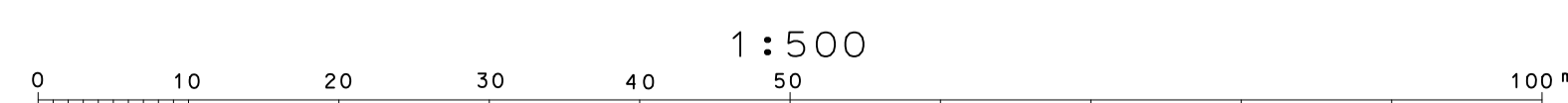

平成二十一年三月三十一日調製

2108-4	2109-3
2208-1	2209-1
2208-3	2209-3

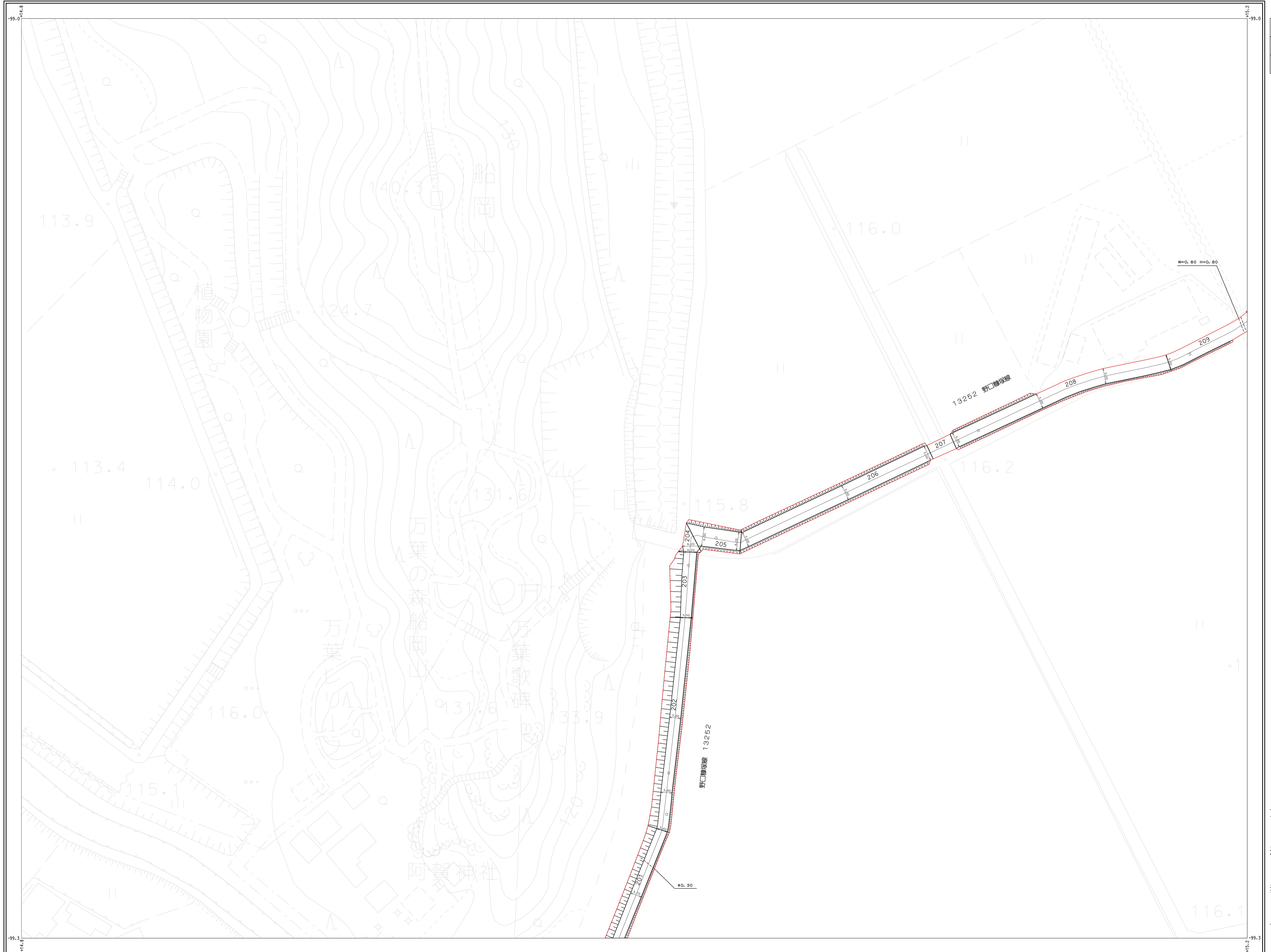
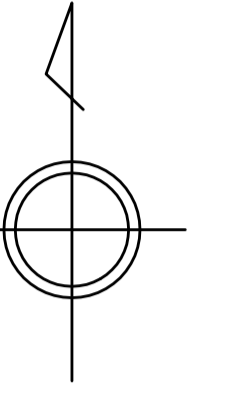

アジア航測株式会社調製

東  
近  
江  
市

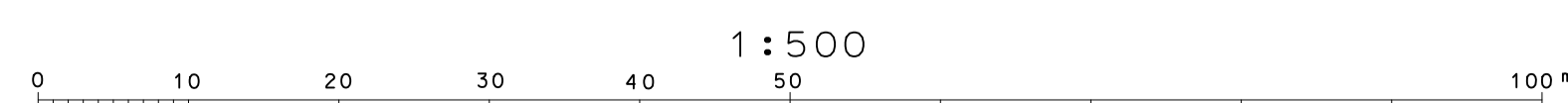

平成二十一年三月三十一日調製

2207-2	2208-1	2208-2
2207-4	2208-3	2208-4
2307-2	2308-1	2308-2

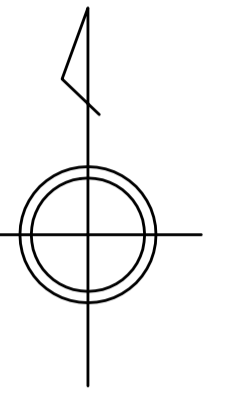

アジア航測株式会社調製

東  
近  
江  
市

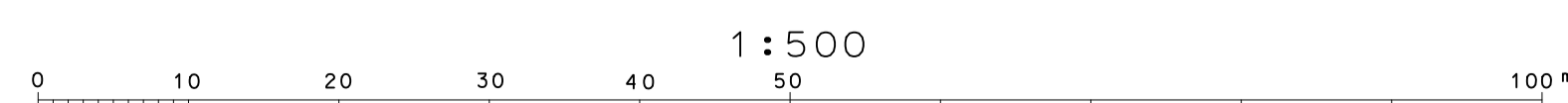



平成二十一年三月三十一日調製

2208-1	2208-2	2209-1
2208-3	2208-4	2209-3
2308-1	2308-2	2309-1

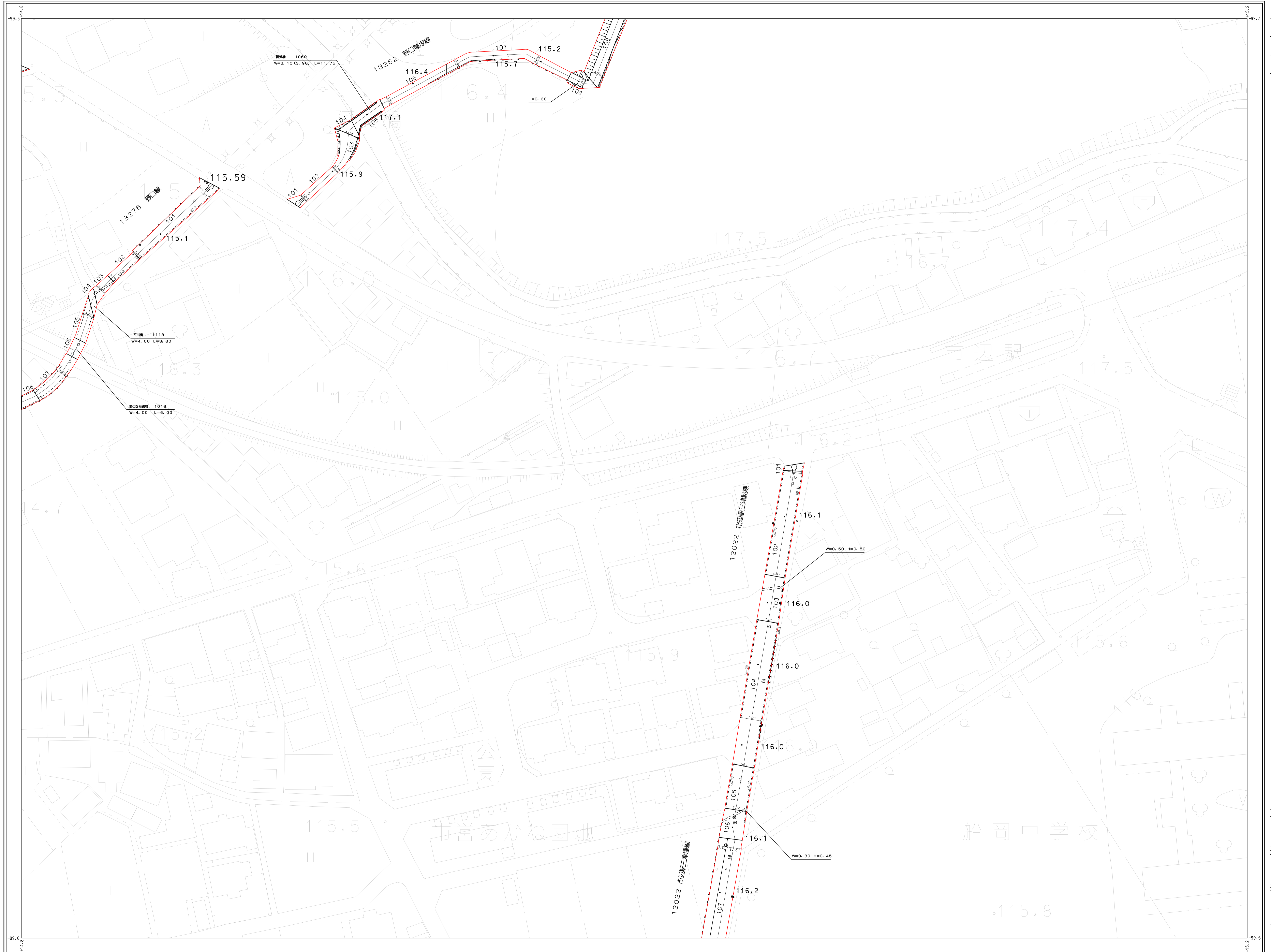
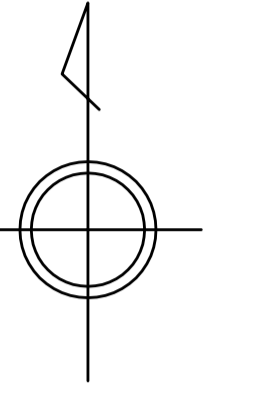

アジア航測株式会社調製

東  
近  
江  
市

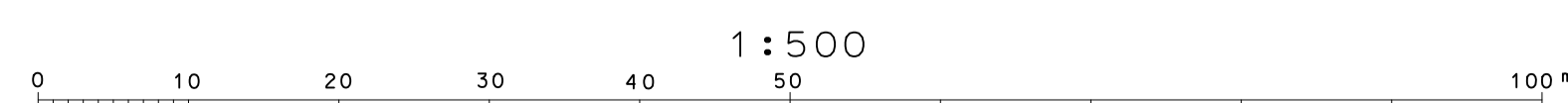

平成二十一年三月三十一日調製

アジア航測株式会社調製

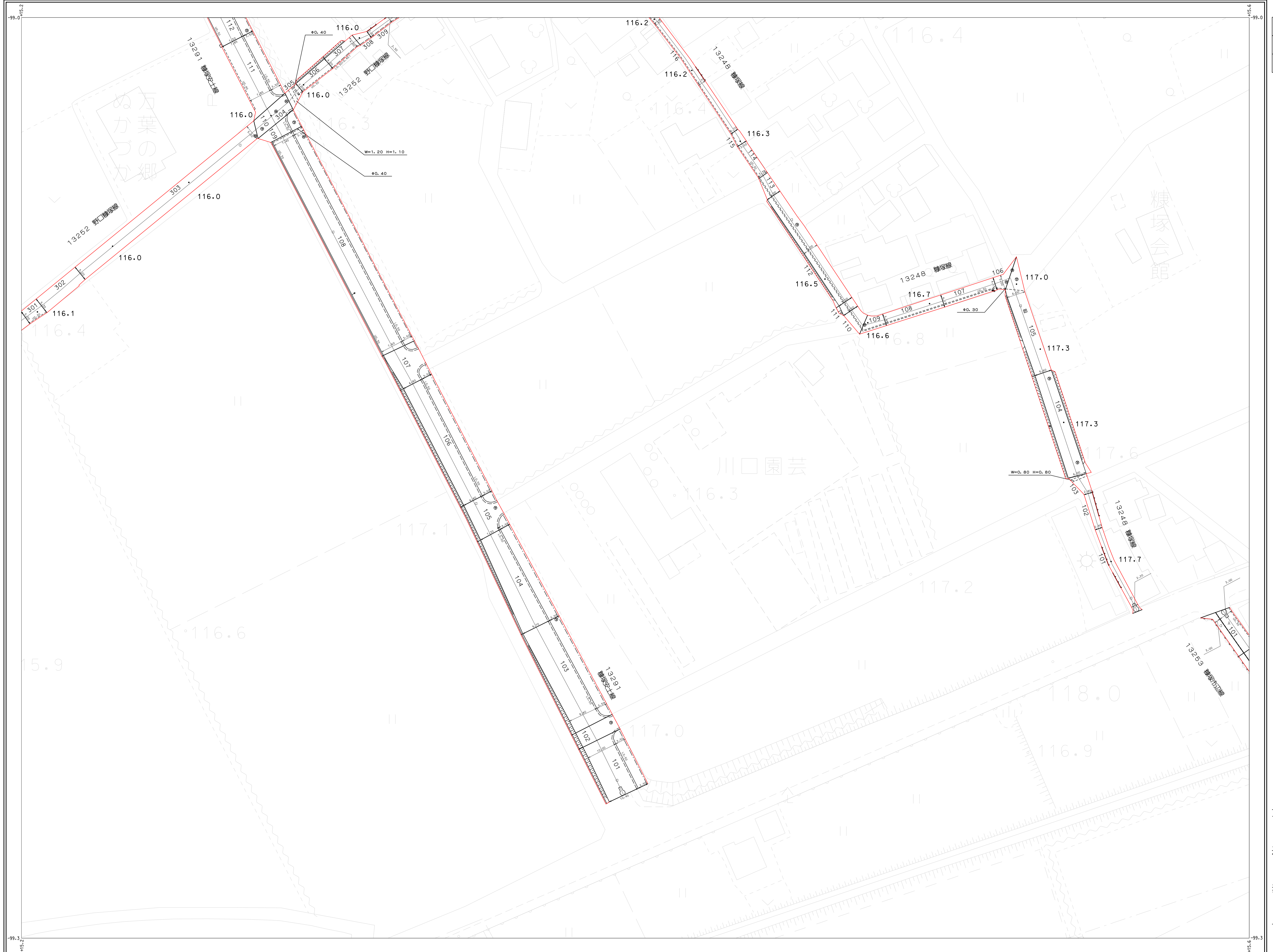

2108-4	2109-3	2109-4
2208-2	2209-1	2209-2
2208-4	2209-3	2209-4

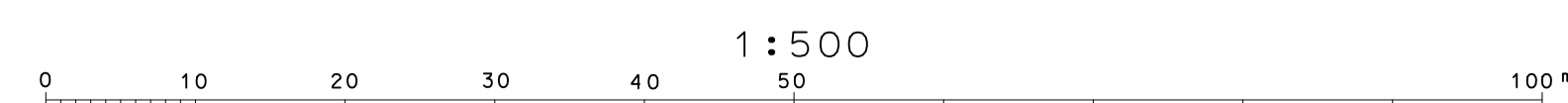
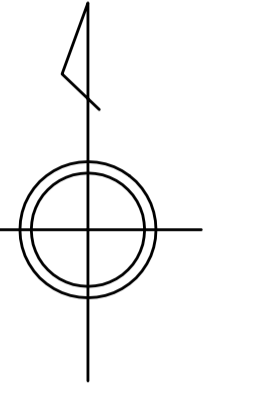

東  
近  
江  
市

平成二十一年三月三十一日調製

2109-3	2109-4	2110-3
2209-1	2209-2	2210-1
2209-3	2209-4	2210-3

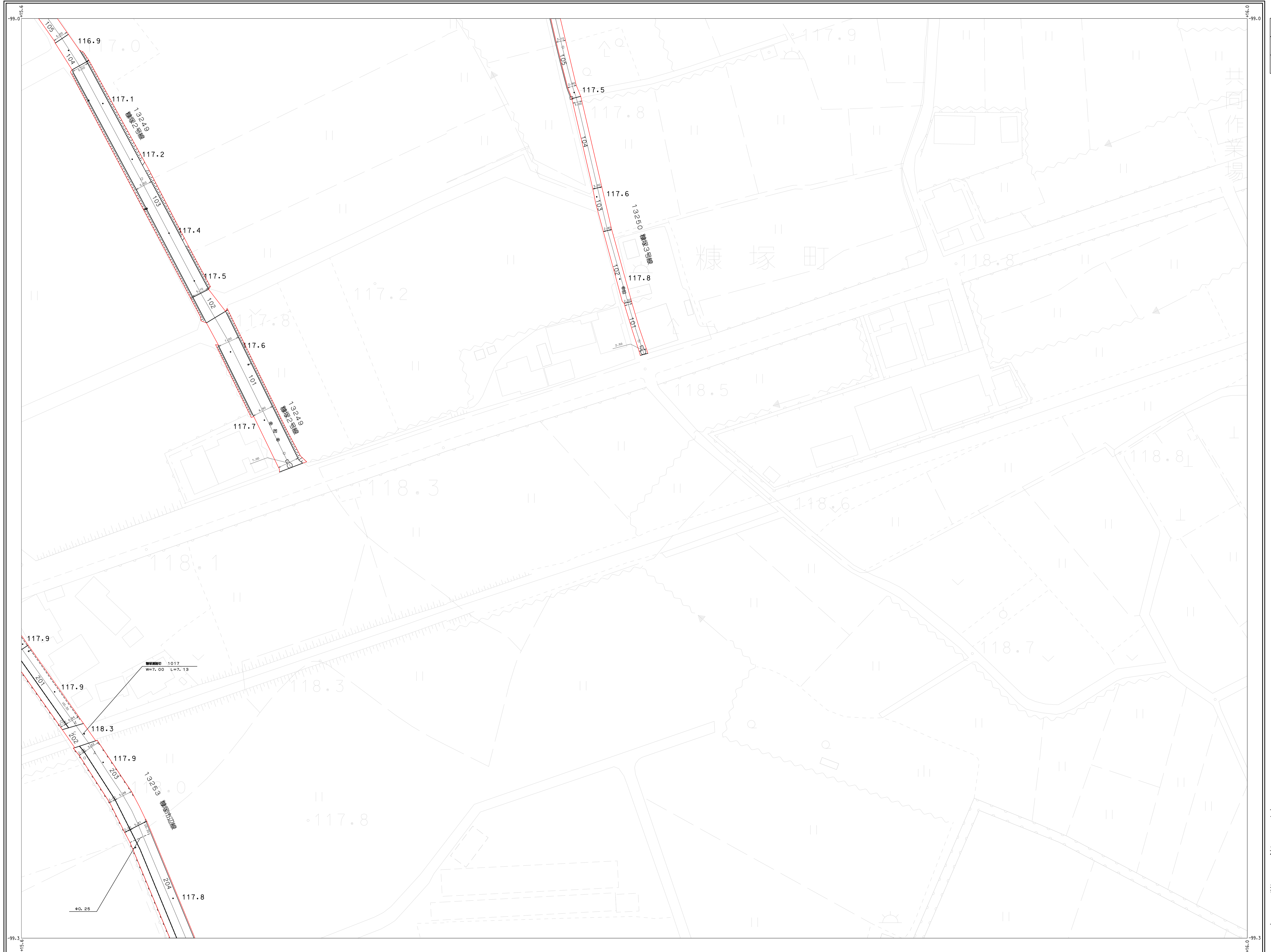
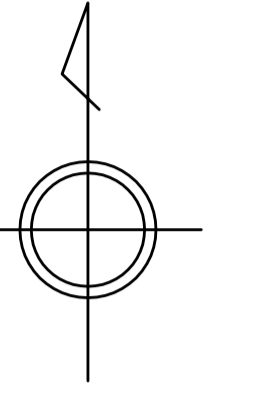

アジア航測株式会社調製

東  
近  
江  
市



平成二十一年三月三十一日調製

2209-1	2209-2	2210-1
2209-3	2209-4	2210-3
2309-1	2309-2	2310-1

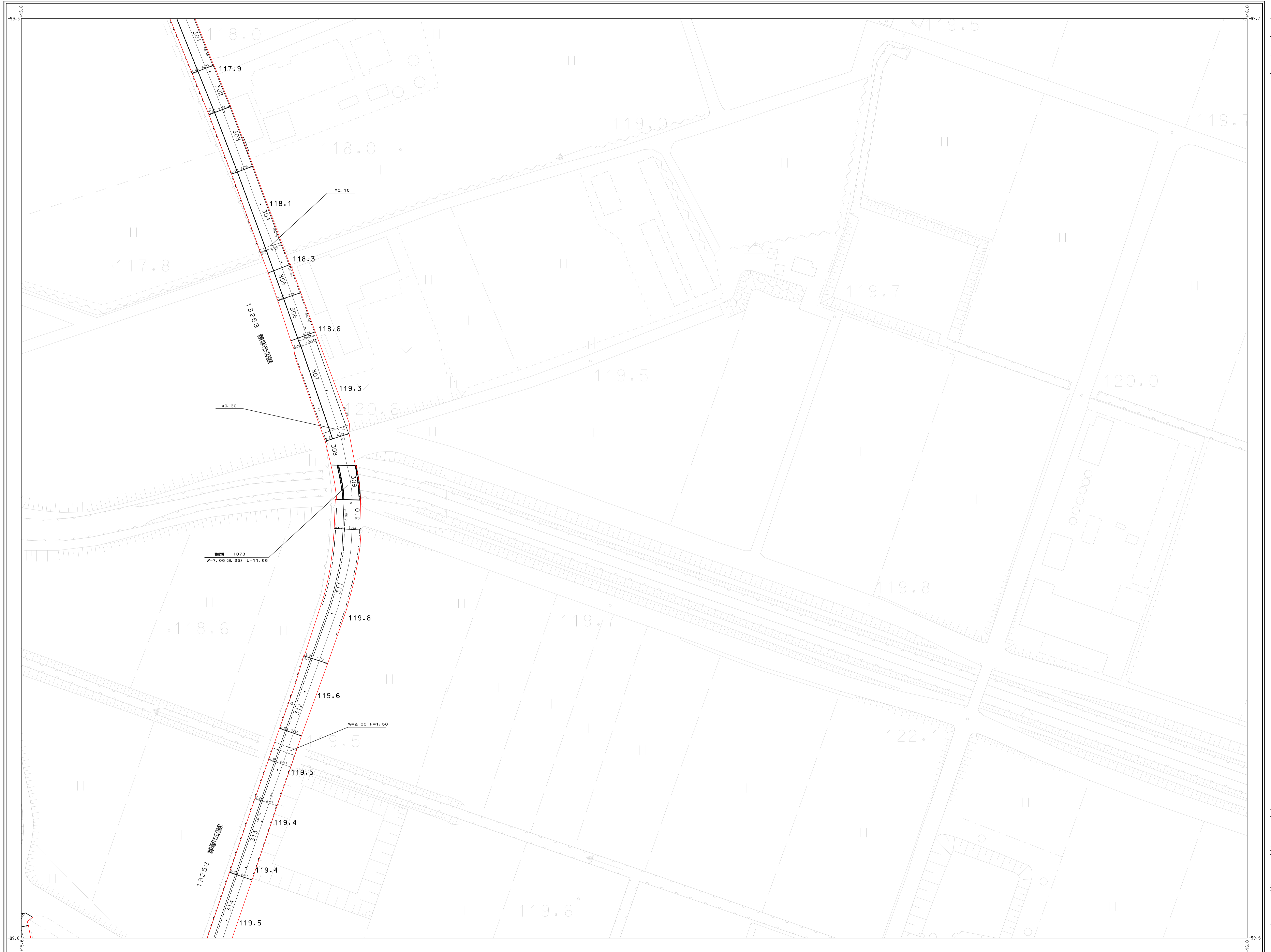
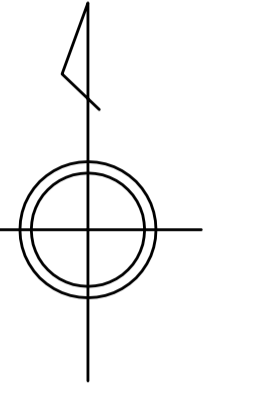

アジア航測株式会社調製

東  
近  
江  
市

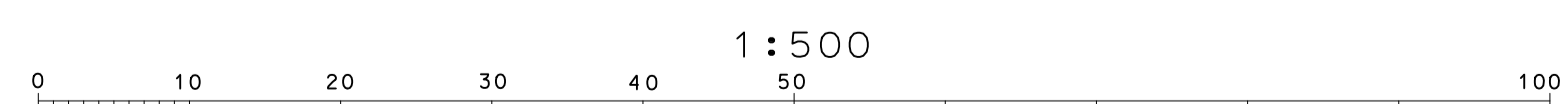

平成二十二年三月三十一日調製

アジア航測株式会社調製



2109-4	2110-3	2110-4
2209-2	2210-1	2210-2
2209-4	2210-3	2210-4

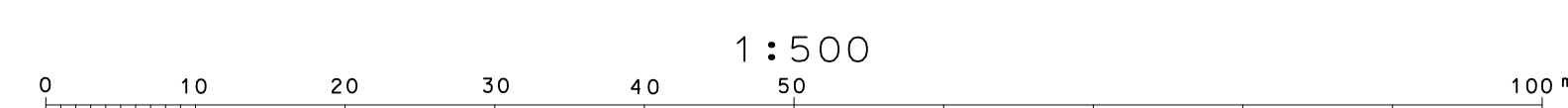
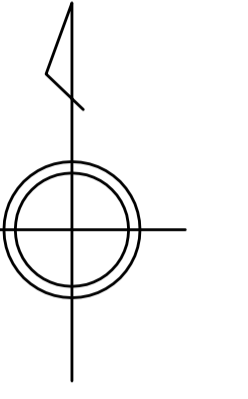

1:500

平成二十一年三月三十一日調製

アジア航測株式会社調製



2110-3	2110-4	2111-3
2210-1	2210-2	2211-1
2210-3	2210-4	2211-3

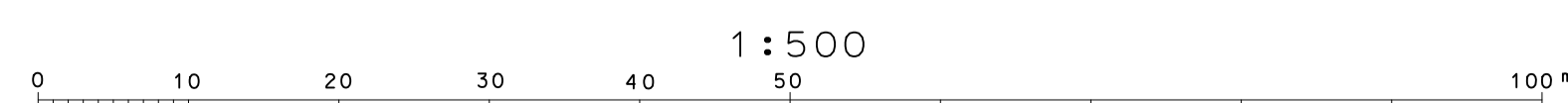
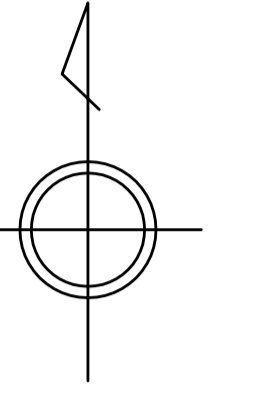

東  
近  
江  
市

平成二十一年三月三十一日調製

アジア航測株式会社調製

2209-2	2210-1	2210-2
2209-4	2210-3	2210-4
2309-2	2310-1	2310-2

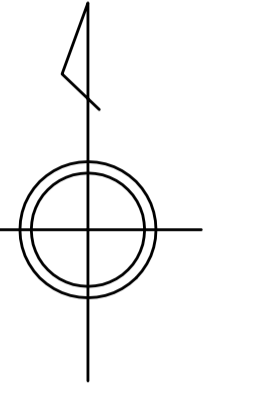

東  
近  
江  
市

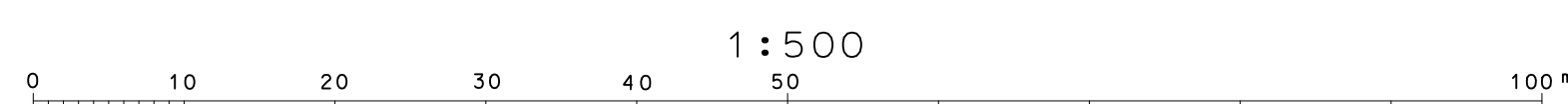



平成二十一年三月三十一日調製  
平成二十二年三月三十一日修正  
平成三十一年三月三十一日修正

2210-1	2210-2	2211-1
2210-3	2210-4	2211-3
2310-1	2310-2	2311-1

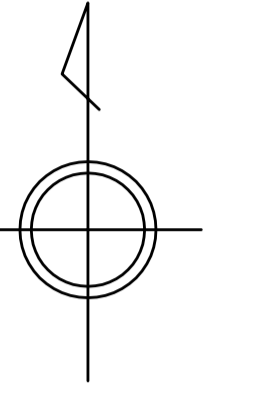

アジア航測株式会社調製

東  
近  
江  
市

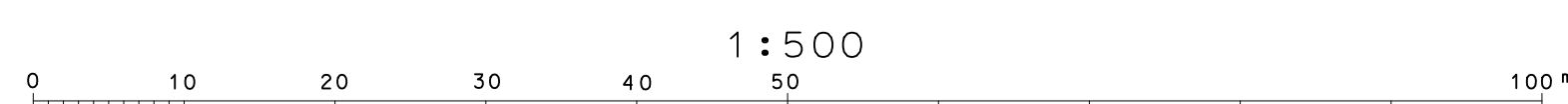



平成二十一年三月三十一日調製  
平成二十四年三月三十一日修正  
平成二十七年三月三十一日修正  
平成二十九年三月三十一日修正  
平成三十一年三月三十一日修正

令和二年三月三十一日修正



2111-3	2111-4	2112-3
2211-1	2211-2	2212-1
2211-3	2211-4	2212-3

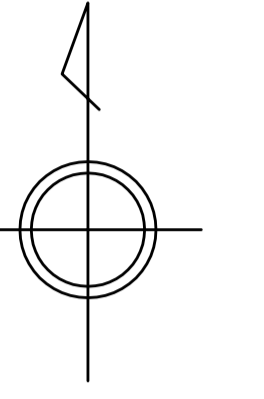

アジア航測株式会社調製

東  
近  
江  
市

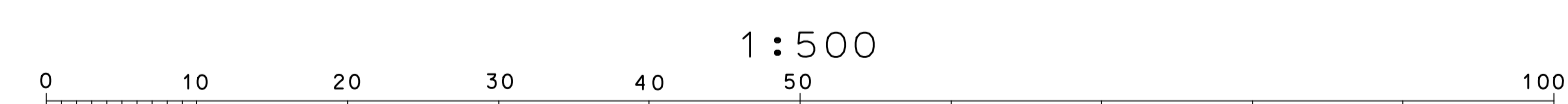

2211-3  
1:500

# 東近江市道路台帳図

(八日市地区)

平成二十二年三月三十一日調査  
平成二十二年三月三十一日修正

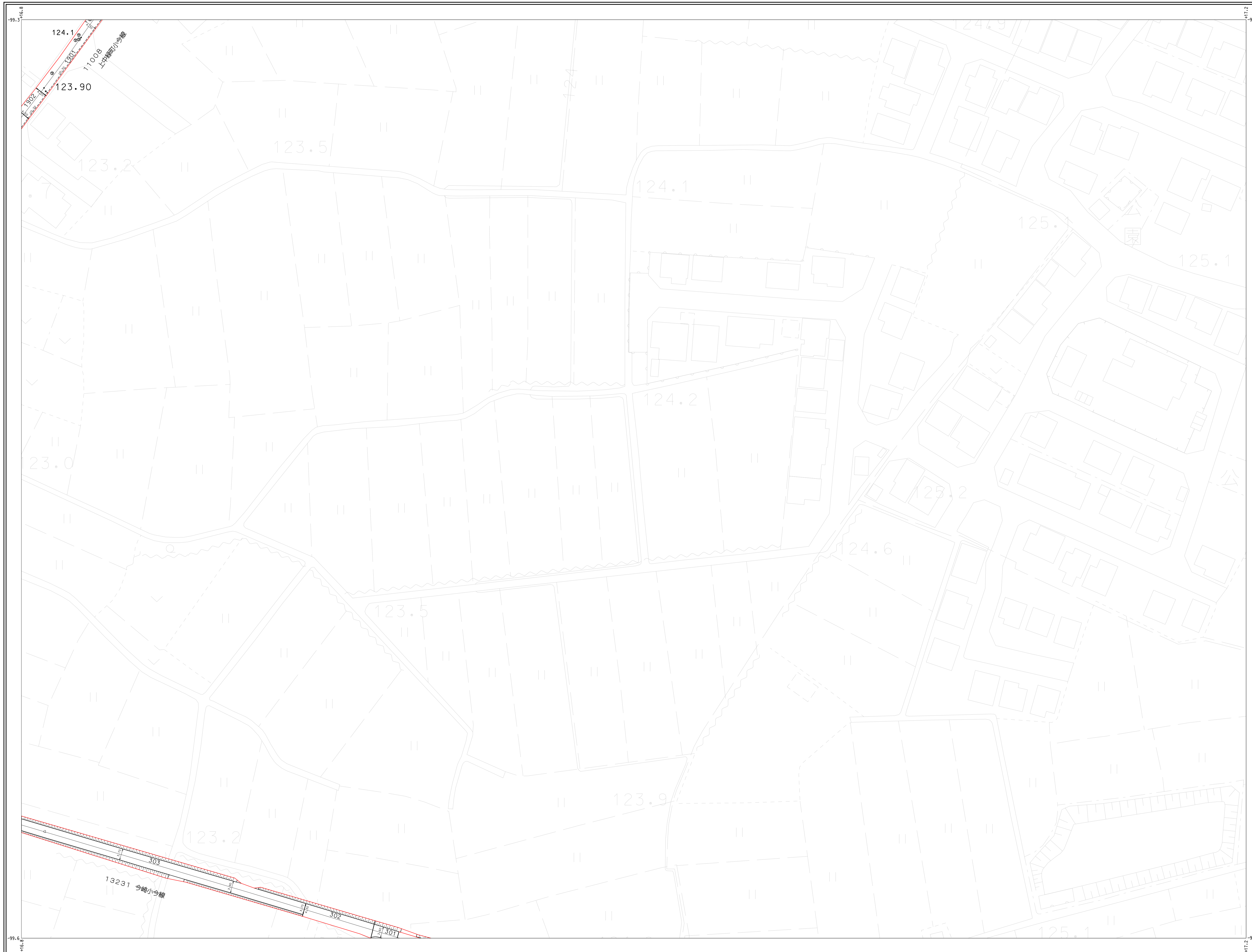

2210-2	2211-1	2211-2
2210-4	2211-3	2211-4
2310-2	2311-1	2311-2

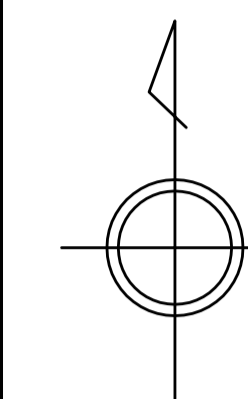

アジア航測株式会社調製

東  
近  
江  
市

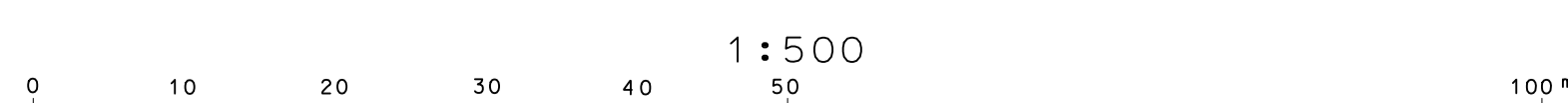

2211-3